



beautifully simple
wetrooms

Simplicity
WETROOMS

We're different

Simplicity Wetrooms has been created with one thing in mind... You!

We believe everyone is unique and therefore their choice and style of bathroom should be able to reflect this.

Luxury finish
Simple pricing
Trimmable to any size
Design service
Lifetime guarantee
24hr Delivery

Simplicity
WETROOMS



Contents

01

Inspiration

07

Guarantee

08

Technical

11

How to order

13

Timber floor kits

21

Timber floor product codes

25

Solid floor product codes

31

Waterproofing & Decoupling

33

Timber floor drawings

34

Solid floor drawings

35

Customer Support





Inspiration

Whatever your style or preference, our innovative and flexible solutions allow the creation of your dream bathroom space, without compromise.

This flexible approach encourages creativity and freedom in design.

The wetroom drain can be positioned almost anywhere within the shower area, without the constraints of pre-determined sizes, offering almost limitless possibilities.



We have solutions for all types of floor construction, whether you're renovating an existing bathroom or building from new.

You could be converting a downstairs cloakroom, updating an en-suite bathroom or creating a stunning family bathroom, whatever your size of project a Simplicity Wetroom will add a touch of style and luxury.

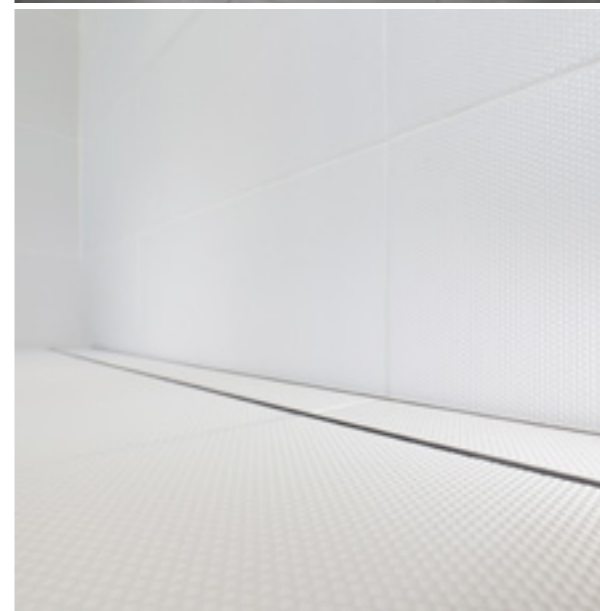

Our continuous approach to design and innovation, coupled with our UK based manufacturing facility, puts us in a unique position to offer the very best technical solutions, backed up by our **Lifetime Guarantee.**

With a desire and passion to succeed, together with an exceptional level of customer service, our mission is to offer unrivalled customer satisfaction to the most important person of all... **You!**



Guarantee

Not all guarantees are the same - at Simplicity Wetrooms we understand the challenges faced by consumers, retailers and installers, from the initial design right through to the installation and beyond.

All of our products are covered by our **Lifetime Guarantee**.

- Complete system guarantee - Drainage & waterproofing
- All components from one manufacturer
- No split responsibility
- Complete peace of mind



Technical

Please read on for a full breakdown of each component

- Drainage
- Gradient
- Waterproofing

Including timber floor kits, full product codes and technical dimensions.



One important feature of any wetroom is to decide on the position of the grill, as this is often the focal point of the room. Positioning the grill against the long wall provides a sleek modern look, with the following benefits:

- Minimalist design
- Water flows away from the entrance of the shower
- No step - complete level access
- Easy to tile one-way gradient
- No diagonal tile cuts
- No need to stand on drain

The drain can also be positioned against the short wall, or off the wall in almost any position within the shower area.

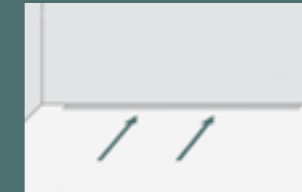

Drain positioned against the long wall



Drain positioned against the short wall



Drain positioned off the wall



Size

Choose the size of your wet area.



Grill finish

Select your desired grill finish.



Flow rate

Choose from 1, 2 or 3 traps, depending on the flow-rate of the shower.



Floor type

Is your floor construction Timber or Solid?



Grill position

Would you like the grill against the long or short wall... or elsewhere?



Waterproofing

Don't forget to add waterproofing for the floor and walls.



Timber floor kits

The simplest way to order.

Choose your preferred layout from the six most popular options *and let us do the rest.*

13-20

Timber floor product codes

Follow the easy to use 4 step process to create your own layout.

21-24

Solid floor product codes

Follow the easy to use 3 step process to create your own layout.

25-30

Waterproofing product codes

Select floor and wall waterproofing options.

31-32

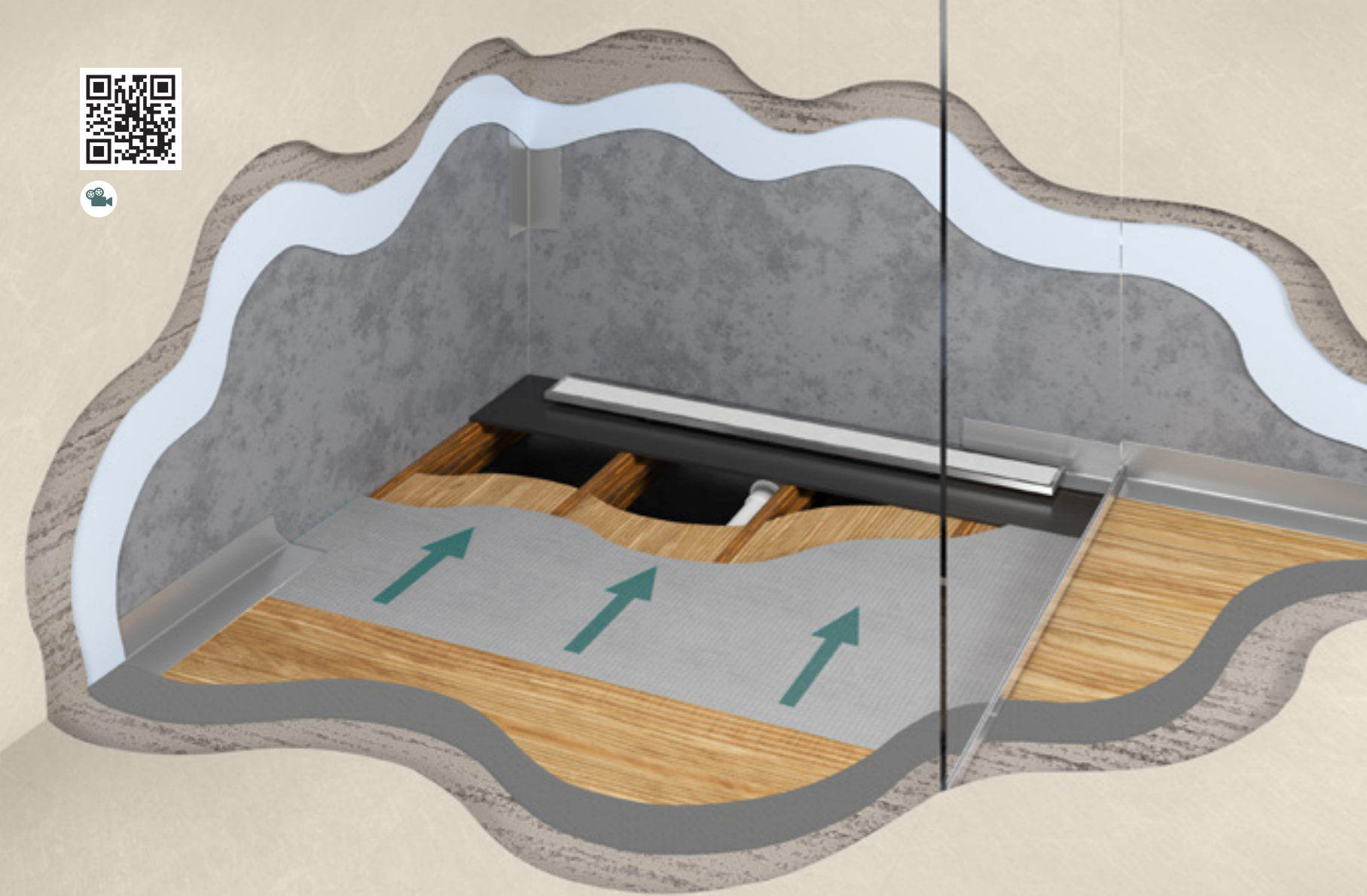

Series 5 Timber Floor

The Series 5 wetroom system offers a unique concept in wetroom design, allowing a shower area of almost any size to be created from a range of stock components.

The easiest way to order is to use the timber floor kits - See p15-20. Alternatively the individual components can be ordered separately using the four steps below - See p21-24.

1. Select the required Drain Body
2. Select the required size/number of Shower Boards
3. Select the required grill length/design
4. Add the waterproofing - See p31-32

Drain against long wall

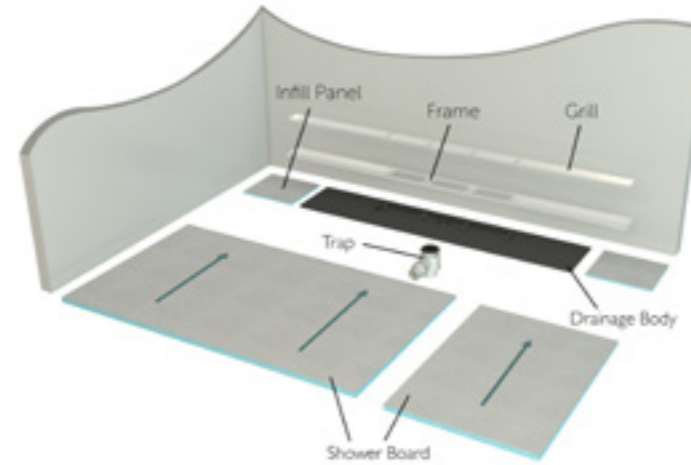

Key Features

- Available from stock with 24 hour delivery
- Unlimited range of sizes up to 1700mm x 2000mm
- Choice of grill finishes
- Grill lengths up to 2000mm
- Multiple trap positions - with 360° outlet
- Lifetime guarantee



Drain against short wall

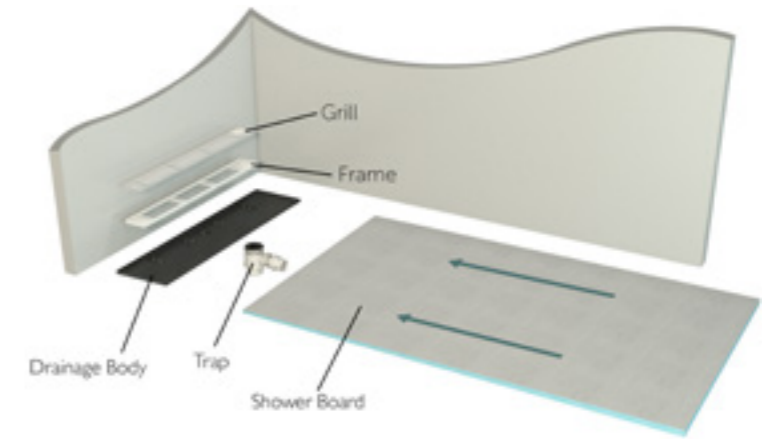

For more information please refer to separate **Series 5** technical literature.

Series 5 Timber Floor

To keep things simple we've put together a series of 6 trimmable timber floor kits which cover the majority of wetroom sizes, with the drain positioned against the long wall. Each kit contains the following;

- Trimmable Drain Body - The central component to all Series 5 kits
- Single Trap - For flow rates up to 24 L/min^{†1}
- Wall Grill & Frame - Height Adjustable
- Trimmable Shower Board(s) - To provide pre-formed gradient
- Tile Trim - To match grill finish

For alternative layouts the components can be ordered individually - See p21-24

The waterproofing is supplied in two parts

W1 Floor Waterproofing Kit - Available in 5m² & 10m² kits

W3 Wall Waterproofing - Available in 8Kg tubs

See p31-32 for full details



Example Kit - Drain Against Long Wall

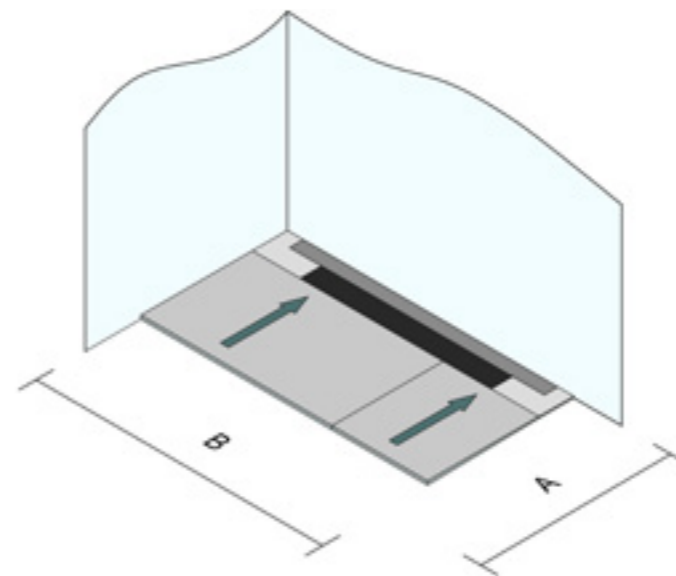

Kit code S5-K5/T12

Dimension **A** can be any size between 700mm - 1700mm
Dimension **B** can be any size between 1501mm - 1800mm

Grill Type **T12** - Tile insert suitable for 10mm-12mm tile/stone

Grill length will be supplied 200mm less than dimension B rounded up/down to the nearest 100mm^{†2}

Always add the waterproofing - See p31-32

Example Kit - Drain Against Short Wall

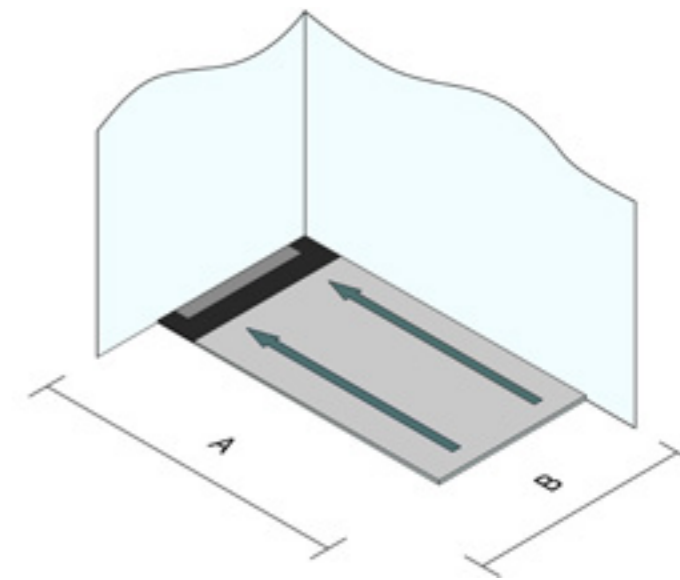

Kit code S5-K2/SD-MB

Dimension **A** can be any size between 1201mm - 1500mm
Dimension **B** can be any size between 700mm - 1200mm

Grill Type **SD-MB** - Solid Grill Matt Black







Grill length will be supplied 200mm less than dimension B rounded up/down to the nearest 100mm^{†2}

Always add the waterproofing - See p31-32

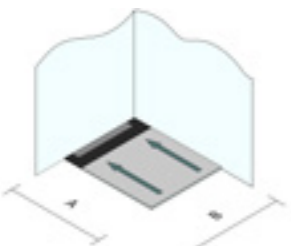
^{†1} All kits are supplied with one trap with a flow rate of up to 24 L/min, see p19 for additional traps.

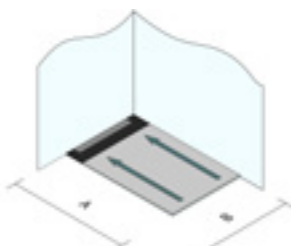

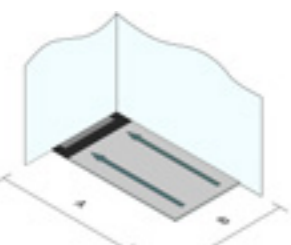



^{†2} See p23-24 for grill finishes. Where dimension B is 850mm or less a 600mm grill will be supplied.

Series 5 Timber Floor Kits - Includes Trimmable Drain Body, Wall Grill, Trimmable Shower Board and Tile Trim.

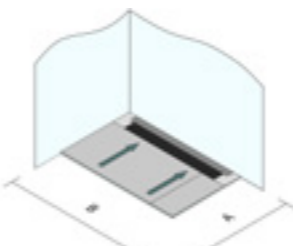
Layout	Grill position	Dimension A	Dimension B	Grill Length	Kit Code	Series 5 Linear Wall Grill
 Up to 1200mm (A) x 1200mm (B)*	Short Wall Flow Rate 24L/min	800mm - 1200mm	700mm - 1200mm		S5-K1/--	 Type T 8, 12, 20  Type T8-MB 8, 12, 20
 Up to 1500mm (A) x 1200mm (B)*	Short Wall Flow Rate 24L/min	1201mm - 1500mm	700mm - 1200mm	The grill will be supplied 200mm less than Dimension B rounded up/down to the nearest 100mm ^{‡1}	S5-K2/--	 Type TF  Type SD
 Up to 1700mm (A) x 1200mm (B)*	Short Wall Flow Rate 24L/min	1501mm - 1700mm	700mm - 1200mm		S5-K3/--	 Type SD-MB See pages 23-24 for full details

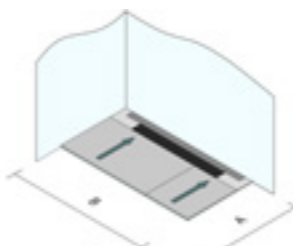

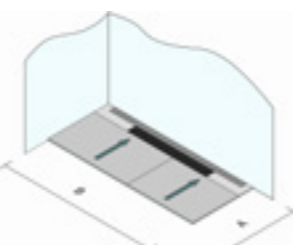
All kits are supplied with one trap with a flow rate of 24 L/min, see page 19 for additional traps. * Trimmable to required size. ^{‡1} Where dimension A is 850mm or less a 600mm grill will be supplied.

Series 5 Timber Floor Kits - Includes Trimmable Drain Body, Wall Grill, Trimmable Shower Board and Tile Trim.

Layout	Grill position	Dimension A	Dimension B	Grill Length	Kit Code	Series 5 Linear Wall Grill
 Up to 1700mm (A) x 1500mm (B)*	Long Wall Flow Rate 24L/min	700mm - 1700mm	1200mm - 1500mm		S5-K4/--	 Type T 8, 12, 20  Type T8-MB 8, 12, 20
 Up to 1700mm (A) x 1800mm (B)*	Long Wall Flow Rate 24L/min	700mm - 1700mm	1501mm - 1800mm	The grill will be supplied 200mm less than Dimension B rounded up/down to the nearest 100mm ^{‡1}	S5-K5/--	 Type TF  Type SD
 Up to 1200mm (A) x 2200mm (B)*	Long Wall Flow Rate 24L/min	700mm - 1700mm	1801mm - 2200mm		S5-K6/--	 Type SD-MB See pages 23-24 for full details

All kits are supplied with one trap with a flow rate of 24 L/min, see page 19 for additional traps. * Trimmable to required size. ^{‡1} Where dimension A is 850mm or less a 600mm grill will be supplied.

Series 5 Timber Floor Kits - Includes Single Trap Drain Body, Wall Grill, Shower Board and Tile Trim

Additional Trap	Description	Code
	Add one additional trap - Flow Rate 41L/min	S5-TP/1
	Add two additional traps - Flow Rate 68L/min	S5-TP/2

Grill finishes

Grill Type T8
Tile insert stainless steel finish - Suitable for 6mm-8mm tiles †¹

Grill Type T8-MB
Tile insert matt black finish - Suitable for 6mm-8mm tiles †¹

Grill Type T12
Tile insert stainless steel finish - Suitable for 10mm-12mm tiles †¹

Grill Type T12-MB
Tile insert matt black finish - Suitable for 10mm-12mm tiles †¹

Grill Type T20
Tile insert stainless steel finish - Suitable for 18mm-20mm tiles †¹

Grill Type T20-MB
Tile insert stainless steel finish - Suitable for 18mm-20mm tiles †¹

Grill Type TF
Frameless tile insert - Suits any tile thickness †¹

Grill Type SD
Solid grill brushed stainless steel finish

Grill Type SD-MB
Solid grill matt black finish

NOTE:
Add Grill finish suffix in red to complete product -
eg S5W-900/T12



†¹ For grill types T greater than 1500mm the tile insert is supplied in two equal sections.

Add the Waterproofing

The waterproofing comes in two parts



W1 Floor Waterproofing Kit - Available in 5m² & 10m² kits

W3 Wall Waterproofing - Available in 8Kg tubs

For full details see page

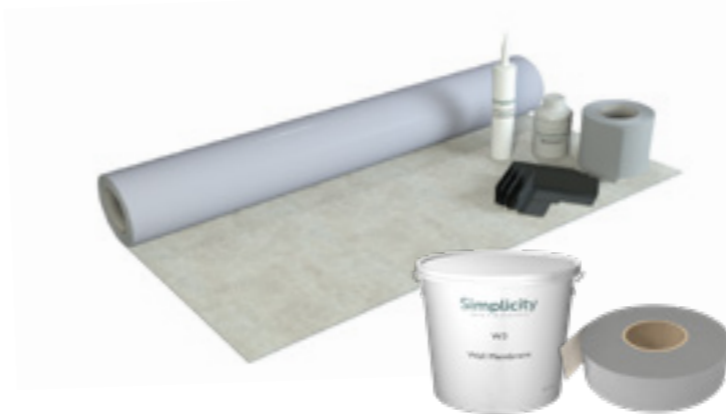
31-32



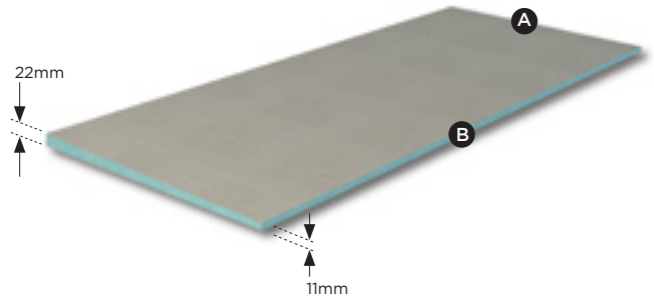

Series 5 Trimmable Drain Body	Description	Code
	Single Trap - Horizontal Outlet - 24 L/min	S5-1H
	Double Trap - Horizontal Outlet - 41 L/min	S5-2H
	Triple Trap - Horizontal Outlet - 68 L/min	S5-3H
	Single Trap - Vertical Outlet - 24 L/min	S5-1V
	Double Trap - Vertical Outlet - 41 L/min	S5-2V
	Triple Trap - Vertical Outlet - 68 L/min	S5-3V

Series 5 Trimmable Infill Panel	Description	Code
	Infill Panel 300mm x 600mm	S5-1P

Series 5 Trimmable Shower Board	Length (A)	Width (B)	Code
	300mm	1200mm	S5WB-03
	500mm	1200mm	S5WB-05
	700mm	1200mm	S5WB-07
	800mm	1200mm	S5WB-08
	900mm	1200mm	S5WB-09
	1000mm	1200mm	S5WB-10
	1100mm	1200mm	S5WB-11
	1200mm	1200mm	S5WB-12
	1500mm	1200mm	S5WB-15

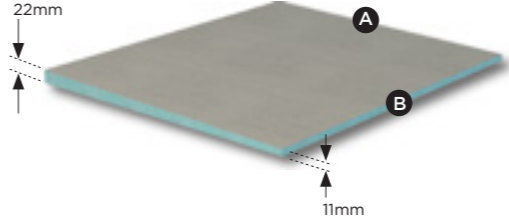
For more information please refer to separate **Series 5** technical literature.

Series 5 Trimmable Shower Board	Length (A)	Width (B)	Code
	300mm	600mm	S5WB-H03
	500mm	600mm	S5WB-H05
	700mm	600mm	S5WB-H07
	800mm	600mm	S5WB-H08
	900mm	600mm	S5WB-H09
	1000mm	600mm	S5WB-H10
	1100mm	600mm	S5WB-H11
	1200mm	600mm	S5WB-H12
	1500mm	600mm	S5WB-H15

Series 5 Trimmable Tile Trim	Length	Stainless Steel Code	Matt Black Code
	Tile Trim for 500mm Wetroom Shower Board	S5TT-05	S5TT-05-MB
	Tile Trim for 700mm Wetroom Shower Board	S5TT-07	S5TT-07-MB
	Tile Trim for 800mm Wetroom Shower Board	S5TT-08	S5TT-08-MB
	Tile Trim for 900mm Wetroom Shower Board	S5TT-09	S5TT-09-MB
	Tile Trim for 1000mm Wetroom Shower Board	S5TT-10	S5TT-10-MB
	Tile Trim for 1100mm Wetroom Shower Board	S5TT-11	S5TT-11-MB
	Tile Trim for 1200mm Wetroom Shower Board	S5TT-12	S5TT-12-MB
	Tile Trim for 1500mm Wetroom Shower Board	S5TT-15	S5TT-15-MB

For more information please refer to separate **Series 5** technical literature.

Series 5 Linear Wall Grill	Length	Code
 Type T 8, 12, 20	600mm	S5W-600/--
	700mm	S5W-700/--
	800mm	S5W-800/--
 Type T8-MB 8, 12, 20	900mm	S5W-900/--
	1000mm	S5W-1000/--
	1100mm	S5W-1100/--
 Type TF	1200mm	S5W-1200/--
	1300mm	S5W-1300/--
	1400mm	S5W-1400/--
 Type SD	1500mm ^{‡1}	S5W-1500/--
	1600mm ^{‡1}	S5W-1600/--
	1700mm ^{‡1}	S5W-1700/--
	1800mm ^{‡1}	S5W-1800/--
 Type SD-MB	1900mm ^{‡1}	S5W-1900/--
	2000mm ^{‡1}	S5W-2000/--

Series 5 Linear Floor Grill	Length	Code
 Type T 8, 12, 20	600mm	S5F-600/--
	700mm	S5F-700/--
	800mm	S5F-800/--
 Type T8-MB 8, 12, 20	900mm	S5F-900/--
	1000mm	S5F-1000/--
	1100mm	S5F-1100/--
 Type TF	1200mm	S5F-1200/--
	1300mm	S5F-1300/--
	1400mm	S5F-1400/--
 Type SD	1500mm ^{‡1}	S5F-1500/--
	1600mm ^{‡1}	S5F-1600/--
	1700mm ^{‡1}	S5F-1700/--
	1800mm ^{‡1}	S5F-1800/--
 Type SD-MB	1900mm ^{‡1}	S5F-1900/--
	2000mm ^{‡1}	S5F-2000/--

Express Bespoke Wall Grill ^{‡1}	Length	Code
Specify length	601-999mm	S5W-EX-601-999/--
 Delivered in 4 Days	1001-1499mm	S5W-EX-1001-1499/--
	1501-1999mm ^{‡1}	S5W-EX-1501-1999/--

Express Bespoke Floor Grill ^{‡1}	Length	Code
Specify length	601-999mm	S5F-EX-601-999/--
 Delivered in 4 Days	1001-1499mm	S5F-EX-1001-1499/--
	1501-1999mm ^{‡1}	S5F-EX-1501-1999/--

For more information please refer to separate **Series 5** technical literature. ^{‡1} For grill types T greater than 1500mm the tile insert is supplied in two equal sections.

Grill finishes

Grill Type T8

Tile insert stainless steel finish - Suitable for 6mm-8mm tiles ^{‡1}

Grill Type T8-MB

Tile insert matt black finish - Suitable for 6mm-8mm tiles ^{‡1}

Grill Type T12

Tile insert stainless steel finish - Suitable for 10mm-12mm tiles ^{‡1}

Grill Type T12-MB

Tile insert matt black finish - Suitable for 10mm-12mm tiles ^{‡1}

Grill Type T20

Tile insert stainless steel finish - Suitable for 18mm-20mm tiles ^{‡1}

Grill Type T20-MB

Tile insert stainless steel finish - Suitable for 18mm-20mm tiles ^{‡1}

NOTE:

Add Grill finish suffix in red to complete product - eg S5W-900/T12



Series 5 Wall Grill

The wall grill is positioned neatly up against the wall to create a one-way gradient within the shower.

Grill position can be adjusted by up to 38mm after the drain has been installed.

Grill width 86mm

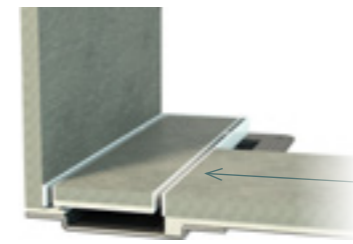

For more information please refer to separate **Series 5** technical literature. ^{‡1} For grill types T greater than 1500mm the tile insert is supplied in two equal sections.

Grill Type TF

Frameless tile insert - Suits any tile thickness ^{‡1}

Grill Type SD

Solid grill brushed stainless steel finish

Grill Type SD-MB

Solid grill matt black finish

Type T

Type SD-MB

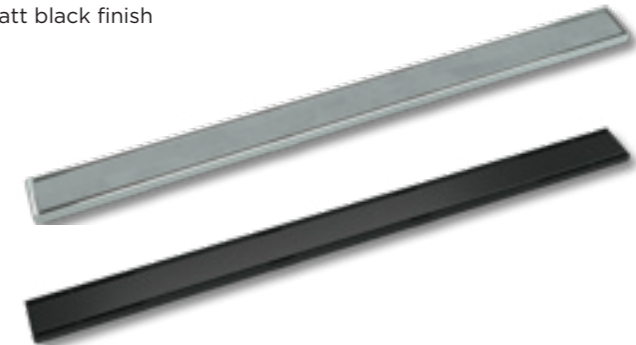

Series 5 Floor Grill

Where the grill is positioned off the wall, use the Floor Grill to create a two way gradient as shown.

Grill width 58mm

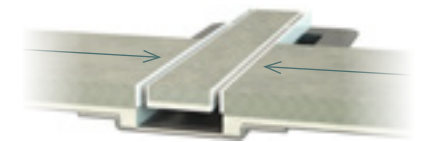

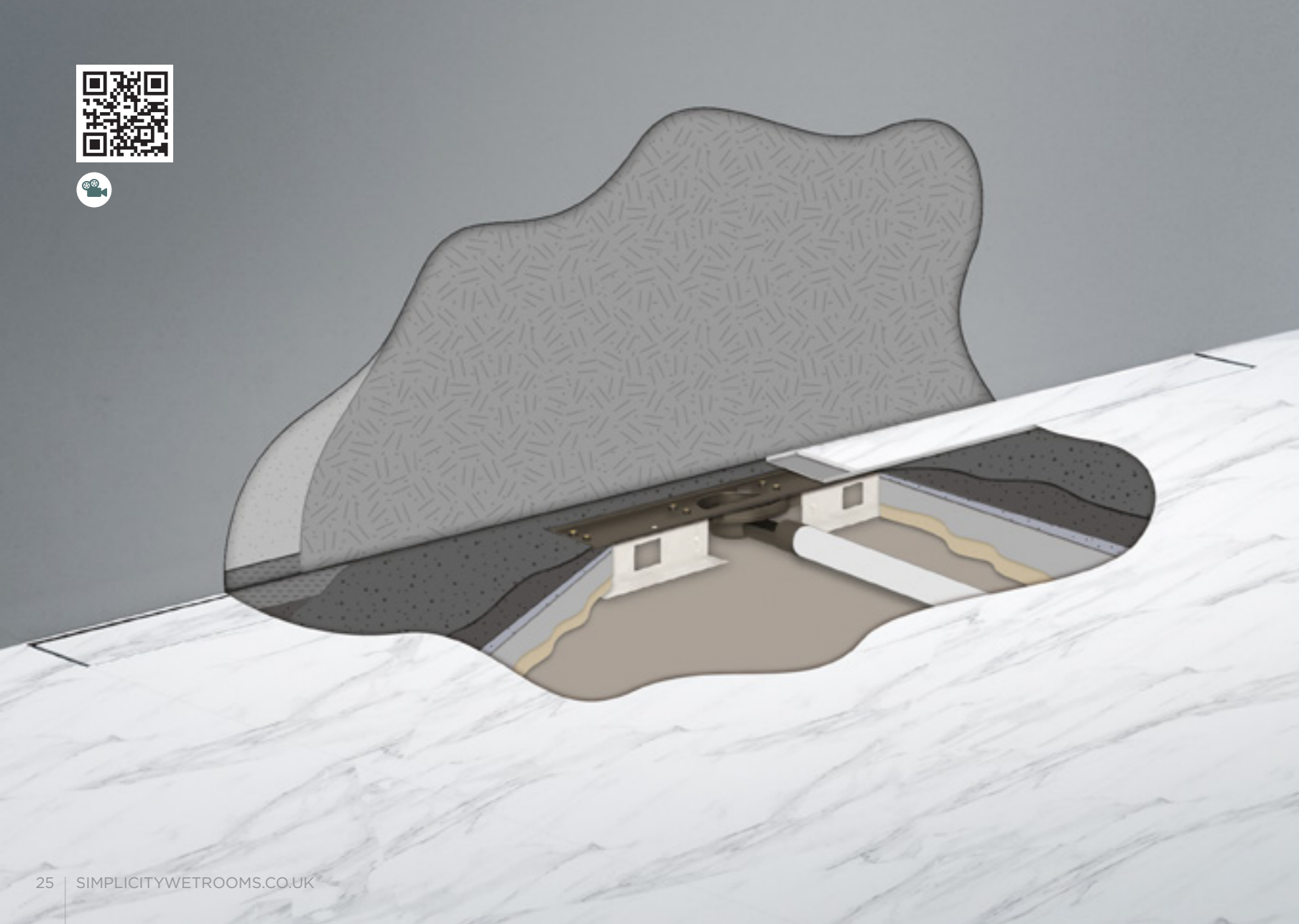

Series 1 Solid Floor

The Series 1 Linear Drain has been designed using our unique waterless trap technology, with a minimum height of only 55mm.

The drain can be installed in almost any position within the shower area, with the gradient created using the Series 1 Shower Board.

Simply follow the four step process below.

1. Select the required Drain Body
2. Select the required size/number of Shower Boards
3. Select the required grill length/design
4. Add the waterproofing - See p31-32

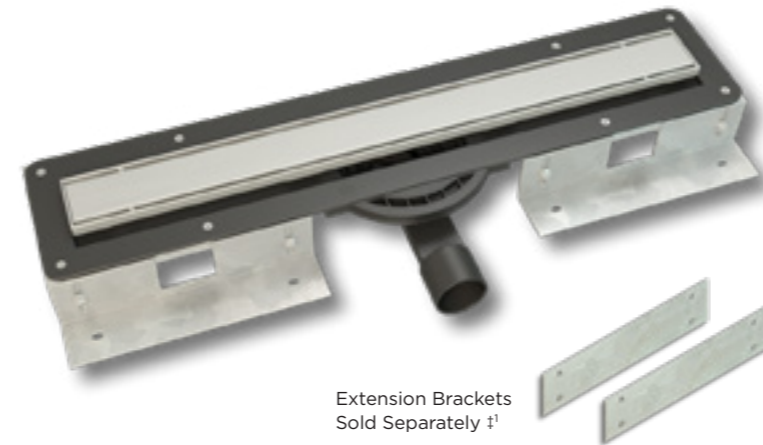

Key Features

- Available from stock with 24 hour delivery
- Grill lengths up to 2000mm
- Choice of grill finishes
- Centre, left and right hand trap position
- 360° rotatable outlet
- Height adjustable
- Lifetime guarantee



For more information please refer to separate **Series 1** technical literature. † Use extension brackets to increase the max height, see p27 for details.

Series 1 Drain Body	Description	Code
	Single Trap - Centre Outlet - 29 L/min	S1-1C
	Single Trap - Left Handed Outlet - 29 L/min	S1-1L
	Single Trap - Right Handed Outlet - 29 L/min	S1-1R
	Double Trap - 56 L/min	S1-2
	Triple Trap - 70 L/min	S1-3

Series 1 Height Extension Brackets	Code
To suit Single Trap - Centre Outlet	S1-1C/EXT
To suit Single Trap - Handed Outlet	S1-1H/EXT
To suit Double Trap	S1-2/EXT
To suit Triple Trap	S1-3/EXT
Each set of extension brackets adds 30mm to the maximum drain height.	

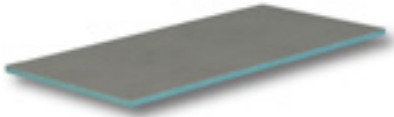
Series 1 Trimmable Infill Panel	Description	Code
	Infill Panel 300mm x 600mm	S1-IP

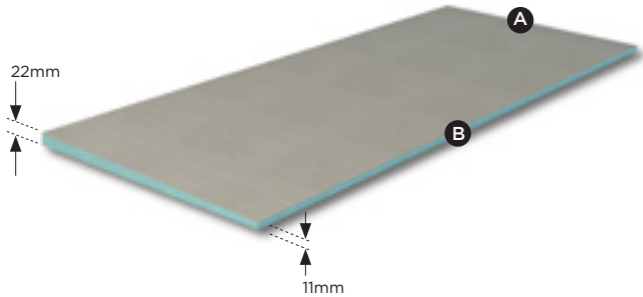
Series 1 Trimmable Shower Board	Length (A)	Width (B)	Code
	300mm	1200mm	S1WB-03
	500mm	1200mm	S1WB-05
	700mm	1200mm	S1WB-07
	800mm	1200mm	S1WB-08
	900mm	1200mm	S1WB-09
	1000mm	1200mm	S1WB-10
	1100mm	1200mm	S1WB-11
	1200mm	1200mm	S1WB-12
	1500mm	1200mm	S1WB-15

For more information please refer to separate **Series 1** technical literature.

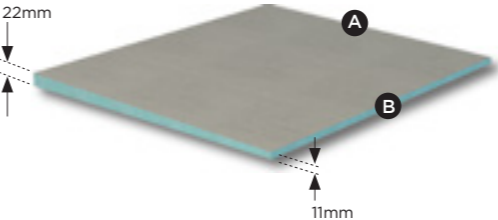
Series 1 Trimmable Shower Board	Length (A)	Width (B)	Code
	300mm	600mm	S1WB-H03
	500mm	600mm	S1WB-H05
	700mm	600mm	S1WB-H07
	800mm	600mm	S1WB-H08
	900mm	600mm	S1WB-H09
	1000mm	600mm	S1WB-H10
	1100mm	600mm	S1WB-H11
	1200mm	600mm	S1WB-H12
	1500mm	600mm	S1WB-H15

Series 1 Trimmable Tile Trim	Length	Stainless Steel Code	Matt Black Code
	Tile Trim for 500mm Wetroom Shower Board	S1TT-05	S1TT-05-MB
	Tile Trim for 700mm Wetroom Shower Board	S1TT-07	S1TT-07-MB
	Tile Trim for 800mm Wetroom Shower Board	S1TT-08	S1TT-08-MB
	Tile Trim for 900mm Wetroom Shower Board	S1TT-09	S1TT-09-MB
	Tile Trim for 1000mm Wetroom Shower Board	S1TT-10	S1TT-10-MB
	Tile Trim for 1100mm Wetroom Shower Board	S1TT-11	S1TT-11-MB
	Tile Trim for 1200mm Wetroom Shower Board	S1TT-12	S1TT-12-MB
	Tile Trim for 1500mm Wetroom Shower Board	S1TT-15	S1TT-15-MB

For more information please refer to separate **Series 1** technical literature.

Series 1 & 2 Linear Wall Grill		Length	Code
	Type T 8, 12, 20	600mm	S1W-600/--
		700mm	S1W-700/--
		800mm	S1W-800/--
	Type T8-MB 8, 12, 20	900mm	S1W-900/--
		1000mm	S1W-1000/--
		1100mm	S1W-1100/--
	Type TF	1200mm	S1W-1200/--
		1300mm	S1W-1300/--
		1400mm	S1W-1400/--
	Type SD	1500mm	S1W-1500/--
		1600mm ^{‡1}	S1W-1600/--
		1700mm ^{‡1}	S1W-1700/--
		1800mm ^{‡1}	S1W-1800/--
		1900mm ^{‡1}	S1W-1900/--
	Type SD-MB	2000mm ^{‡1}	S1W-2000/--

Series 1 & 2 Linear Floor Grill		Length	Code
	Type T 8, 12, 20	600mm	S1F-600/--
		700mm	S1F-700/--
		800mm	S1F-800/--
	Type T8-MB 8, 12, 20	900mm	S1F-900/--
		1000mm	S1F-1000/--
		1100mm	S1F-1100/--
	Type TF	1200mm	S1F-1200/--
		1300mm	S1F-1300/--
		1400mm	S1F-1400/--
	Type SD	1500mm	S1F-1500/--
		1600mm ^{‡1}	S1F-1600/--
		1700mm ^{‡1}	S1F-1700/--
		1800mm ^{‡1}	S1F-1800/--
		1900mm ^{‡1}	S1F-1900/--
	Type SD-MB	2000mm ^{‡1}	S1F-2000/--

Express Bespoke Wall Grill ^{‡1}	Length	Code
Specify length	601-999mm	S1W-EX-601-999/--
 Delivered in 4 Days	1001-1499mm	S1W-EX-1001-1499/--
	1501-1999mm ^{‡1}	S1W-EX-1501-1999/--

Express Bespoke Floor Grill ^{‡1}	Length	Code
Specify length	601-999mm	S1F-EX-601-999/--
 Delivered in 4 Days	1001-1499mm	S1F-EX-1001-1499/--
	1501-1999mm ^{‡1}	S1F-EX-1501-1999/--

For more information please refer to separate **Series 1** technical literature. ^{‡1} For grill types T greater than 1500mm the tile insert is supplied in two equal sections.

Grill finishes

Grill Type T8

Tile insert stainless steel finish - Suitable for 6mm-8mm tiles ^{‡1}

Grill Type T8-MB

Tile insert matt black finish - Suitable for 6mm-8mm tiles ^{‡1}

Grill Type T12

Tile insert stainless steel finish - Suitable for 10mm-12mm tiles ^{‡1}

Grill Type T12-MB

Tile insert matt black finish - Suitable for 10mm-12mm tiles ^{‡1}

Grill Type T20

Tile insert stainless steel finish - Suitable for 18mm-20mm tiles ^{‡1}

Grill Type T20-MB

Tile insert stainless steel finish - Suitable for 18mm-20mm tiles ^{‡1}

NOTE:

Add Grill finish suffix in red to complete product - eg S1W-900/**T12**



Series 1 Wall Grill

The wall grill is positioned neatly up against the wall to create a one-way gradient within the shower.

Grill position can be adjusted by up to 38mm after the drain has been installed.

Grill width 86mm

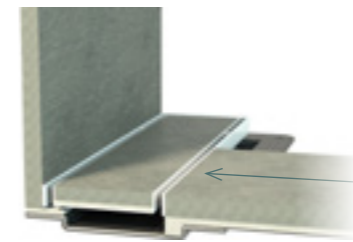

For more information please refer to separate **Series 1** technical literature. ^{‡1} For grill types T greater than 1500mm the tile insert is supplied in two equal sections.

Grill Type TF

Frameless tile insert - Suits any tile thickness ^{‡1}

Grill Type SD

Solid grill brushed stainless steel finish

Grill Type SD-MB

Solid grill matt black finish

Type T

Type SD-MB

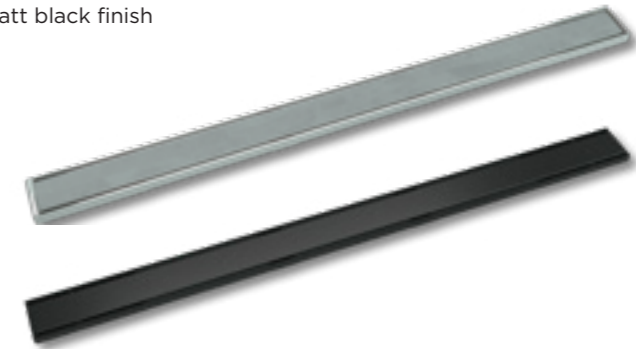

Series 1 Floor Grill

Where the grill is positioned off the wall, use the Floor Grill to create a two way gradient as shown.

Grill width 58mm

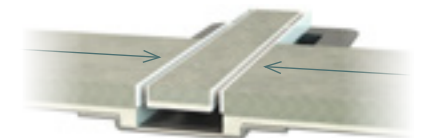



Series W1 Waterproofing & Decoupling

W1 is a self-adhesive waterproofing and decoupling floor membrane designed specifically for use in wetrooms.

It is quick and easy to apply and guaranteed not to leak, whilst also acting as an anti-fracture membrane to prevent tiles from cracking.

Floor Membrane - Key Features

- Self-Adhesive - Quick and easy to apply
- Decoupling **up to 10mm**
- Supplied as a kit
- Lifetime Guarantee
- Ready to tile immediately
- 1mm Factory controlled thickness
- Suitable for use with underfloor heating



For more information please refer to separate **W1 & W3** technical literature.

Series W3 Waterproofing

W3 is a quick drying single coat liquid wall membrane with superior elasticity designed for use in bathrooms, wetrooms and showers.

Wall junctions and niches should be supported using W3 Reinforcing Tape

Wall Membrane - Key Features

- Single coat
- Quick and easy to apply
- Touch dry in 30 minutes
- Ready to tile in 24 hours
- Coverage 8m²
- Lifetime Guarantee
- Use with W3 Reinforcing Tape



For more information please refer to separate **W1 & W3** technical literature.



W1 Floor Membrane Kit	Description	Code
	W1 Kit 5m² - Kit contains 5m x 1m Membrane, 4 pre-formed corners, 10m reinforced tape, 500ml primer, 290ml joint compound	W1K-5
	W1 Kit 10m² - Kit contains 10m x 1m Membrane, 4 pre-formed corners, 15m reinforcing tape, 1ltr primer, 290ml joint compound	W1K-10
	Extra W1 self-adhesive reinforcing tape 125mm x 10m	W1T-10

W1 Ancillaries	Description	Code
	W1 jointing compound 290ml	W1-JC
	W1 primer 500ml	W1-PRI/05
	W1 primer 1ltr	W1-PRI/1L
	W1 pre-formed internal corner pk2	W1-INT
	W1 pre-formed external corner pk2	W1-EXT

W3 Wall Membrane	Description	Code
	W3 wall membrane 8kg (coverage 1kg/m ²)	W3M-8
	W3 self-adhesive reinforcing tape 75mm x 10mm	W3T-10

Drain against the wall

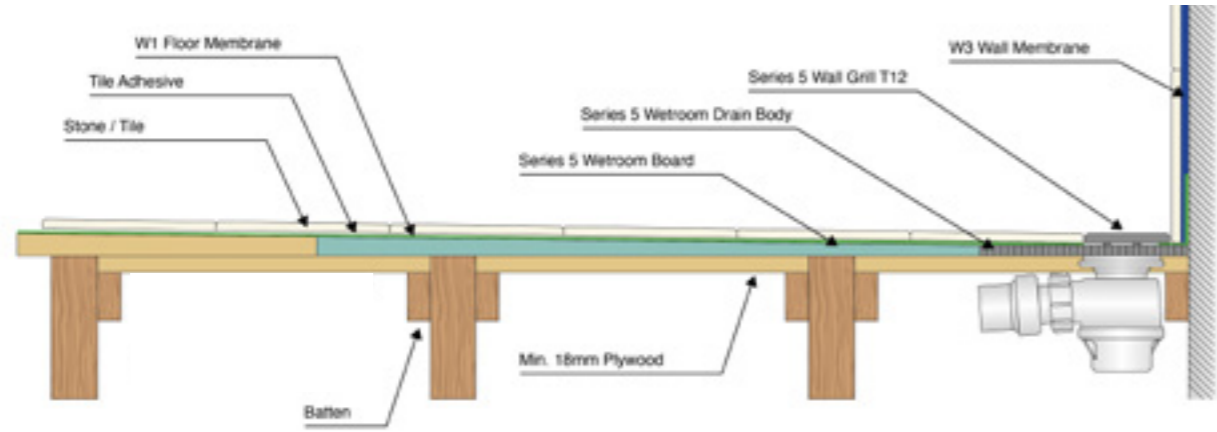

Drain off the wall

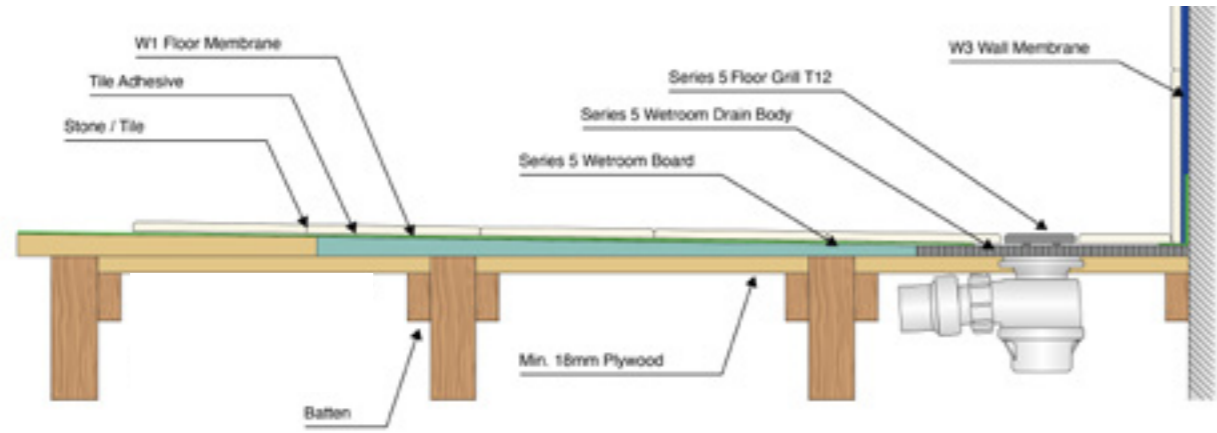

Drain against the wall

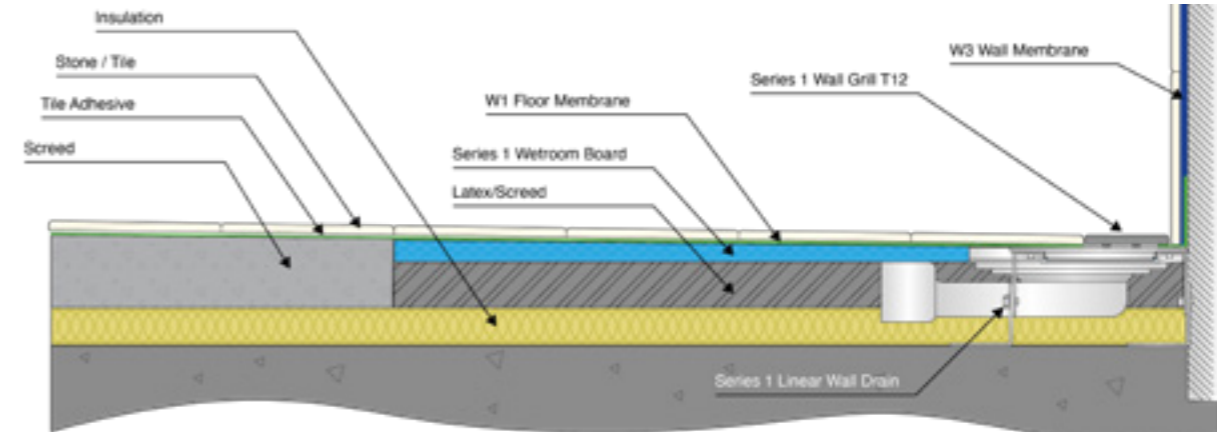

Drain off the wall

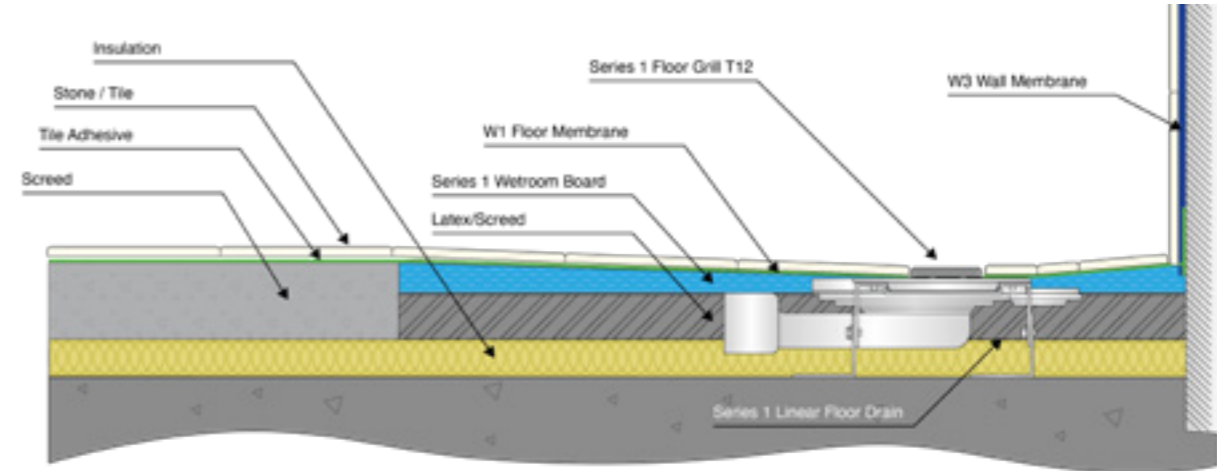

Simplicity

WETROOMS

Design Service

With years of experience our customer support team are happy to assist, from the initial design right through to the installation.

Simply supply a basic sketch of the bathroom with dimensions using the graph paper on p36 or in your own format, and we'll return a list of required components.

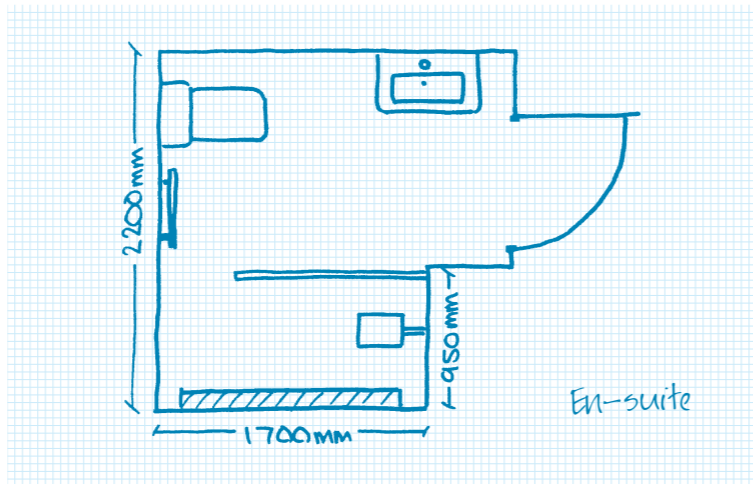

Installer Support

We're very focused on designing our system to be as easy to install as possible.

Each kit is supplied with a personalised layout drawing and an itemised check list detailing the kit contents and how they should be installed.†

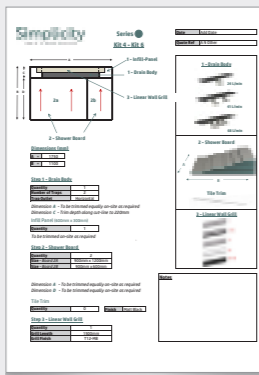

† Series 5 Timber floor kits only - see pages 13-19.

Product Animations

Scan here for our latest product animations



Series 5
Timber Floors



Series 1
Solid Floors



Simplicity
WETROOMS

simplicitywetrooms.co.uk

